

## Parrilla Horizontal mod GHPI 7/700

**Dimensiones:**

700 mm (l) x 850 mm (a) x 700 mm (p)

**Área de parrilla:** 523mm x 537mm

**Peso:** 142,5 kg

**Caudal térmico:** 18,6 kw

**Tipo:** A

**Categoría:** II<sub>2H3+</sub>

**Tension:** 230 V

**Potencia eléctrica:** 0,6 w

**Gás - Butano**

Pression - 28-30 mbar

Consumo total - 1,4 kg/h

**Gás - Propano**

Pression - 37 mbar

Consumo total - 1,4 kg/h

**Gás - Natural**

Pression - 20 mbar

Consumo total - 2,1 m<sup>3</sup>/h



raspador

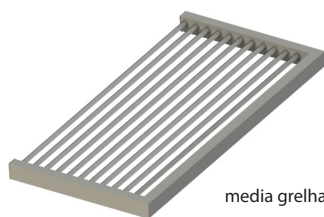

media grelha



Parrillas con entrada y salida de agua

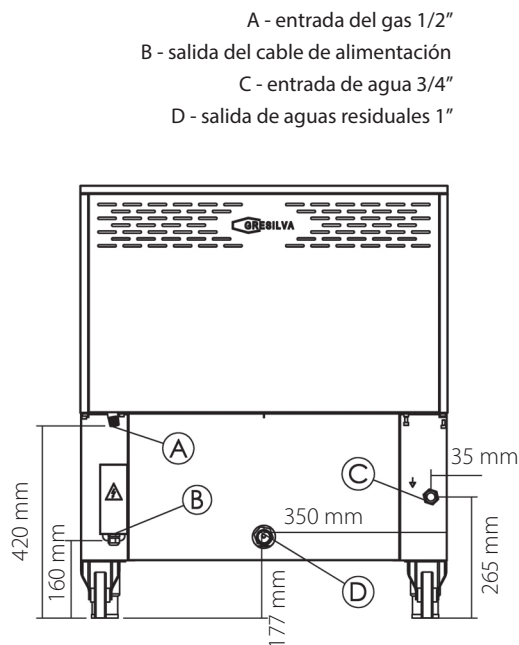
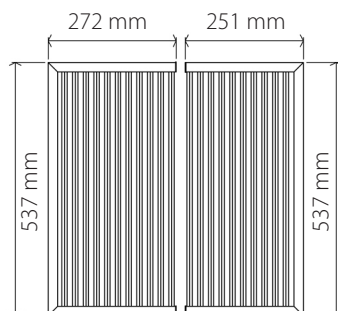
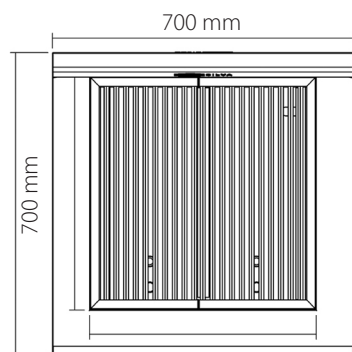
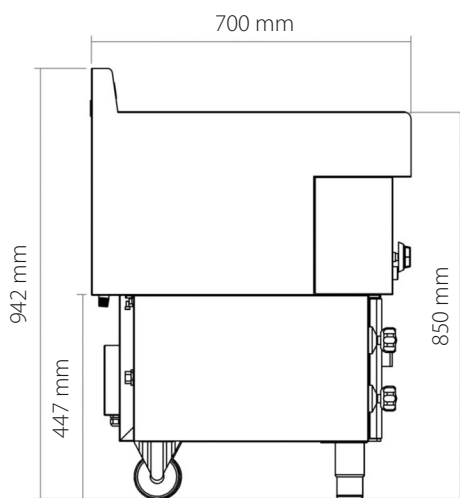
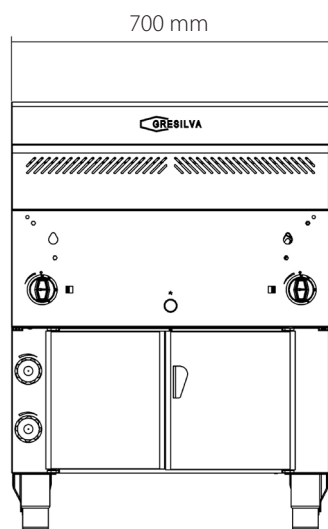

- A - entrada del gas 1/2"
- B - salida del cable de alimentación
- C - entrada de agua 3/4"
- D - salida de aguas residuales 1"

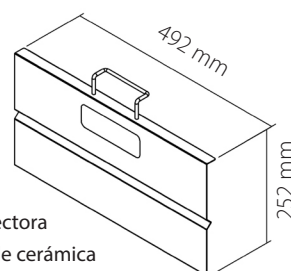

Placa protectora de platos de cerámica